



TABLE GYNÉCOLOGIQUE ÉLECTRIQUE  
ELECTRIC GYNECOLOGICAL TABLE

# ELANSA



11614-01  
avec accessoires / with accessories

Version : 01-2019



# ELANSA

L'EFFICACITÉ  
ET LA SIMPLICITÉ D'UTILISATION  
THE EFFICIENCY EASY TO USE

## CONFORT COMFORT

- 1 moteur électrique
- Dossier réglable par vérin à gaz
- Ancrages bilatéraux pour colposcope
- Mouvement combiné de l'élévation et du dossier
- Commande au pied
- 1 actuator
- Gas-spring assisted backrest
- Bilateral receptacle for optional colposcope holder
- Combined motion of the height and backrest
- Foot control



## SÉCURITÉ / SAFETY

- Capacité 170 kg
- Position d'urgence 11°
- Borne d'équipotentialité : permet l'égalisation des potentiels entre différents dispositifs électromédicaux
- Capacity 170 kg
- Emergency position 11°
- Equipotential bonding conductor: enables to equalise the potentials between different electromedical devices



## HYGIÈNE HYGIENE

- Sellerie anatomique amovible sans couture
- Structure acier avec habillage gris nuage
- Support rouleau papier
- Bac ABS coulissant et amovible sur rails
- Coussin d'assise étanche
- Roulettes à freins (option)
- Removable formed seamless upholstery
- Steel frame with light grey ABS casing
- Paper roll holder
- Sliding and removable plastic pan on rails
- Waterproof seatrest
- Casters with brakes (option)



Modèle présenté avec options/accessoires  
Products shown with options/accessories

## ACCESSIBILITÉ ACCESSIBILITY

- Hauteur variable électrique de 46 à 106 cm
- Décrochement de la base pour s'approcher du patient
- Possibilité de pratiquer un examen général (coussin en accessoire)
- 3 modèles pour s'adapter à toutes les pratiques (Étriers, Goeppel, Repose-pieds)
- Variable height from 46 to 106 cm
- Cutout in the base for more accessibility to patient
- Versatility of the table (gynecology and general examination with the cushion as accessory)
- 3 models to adapt to various practices (Stirrup, Goeppels, Footrests)



Accueil  
Welcome



Examen général  
General examination



Gynécologie  
Gynecology



Position d'urgence  
Emergency position

## CARACTÉRISTIQUES STANDARDS

Hauteur variable électrique de 46 à 106 cm  
 Mouvements combinés de l'élévation et du dossier (1 moteur)  
 Inclinaison du dossier par vérin à gaz  
 Borne équipotentielle  
 Commande par pédale  
 Patins de réglage sous piètement  
 Bac ABS coulissant et amovible sur rails (capacité 6 litres)  
 Point d'ancrage bilatéral pour les accessoires supports colposcope  
 Structure acier avec habillage gris nuage  
 Sellerie anatomique amovible sans couture  
 Support rouleau papier (longueur maxi 50 cm - ø 12,5 cm)  
 Poids maximum du patient autorisé 170 kg  
 (testé en dynamique à 210 kg et en statique à 680 kg)

## STANDARD FEATURES

Electric height adjustment from 46 to 106 cm  
 Combined height and backrest movements (1 actuator)  
 Gas-spring assisted backrest adjustment  
 Equipotential terminal  
 Foot control  
 Adjustable levellers under the base  
 Sliding and removable plastic pan on rails (6 litre capacity)  
 Bilateral anchor points for the colposcope holder 's accessories  
 Steel frame with light grey ABS casing  
 Removable formed seamless upholstery  
 Paper roll holder (max. length 50 cm - ø 12,5 cm)  
 170 kg maximum patient weight capacity (tested at a dynamic weight of 210 kg and a static weight of 680 kg)

Modèles Models	Goepfels	Goepfels	Étriers Stirrups	Repose-pieds Footrest
11610-01			●	
11614-01	●			
11615-01				●

### Options\*

\* A demander impérativement lors de la commande, montage usine / Plant installed, must be ordered with initial order



81036  
 4 roulettes ø 5 cm avec freins  
 (Hauteur + 5 cm)  
 4 castors ø 5 cm with brakes  
 (Height + 5 cm)



12851-01  
 Paire de sangles pour appui  
 jambes goepfels  
 Pair of retention straps  
 for legrest

### Accessoires Accessories

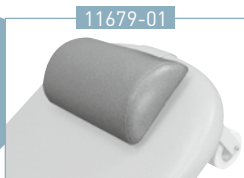

11679-01  
 Appui-tête réglable  
 Adjustable headrest



11372-01  
 Coussin obturateur avec  
 support mural  
 Fill-in cushion with wall support  
 (pour/for 11615-01)

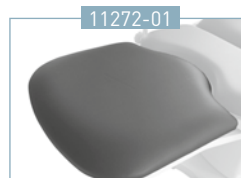

11272-01  
 Coussin de pied amovible  
 avec support mural  
 Removable leg cushion  
 with wall support  
 (pour/for 11610-01 & 11614-01)



2985-01+11910-01  
 Tige porte-sérum autobloquant  
 2 crochets  
 Auto-locking 2 hook IV pole



12677-01  
 Grille anti-éclaboussures  
 Splash guard cover



11910-01  
 Support accessoire ø 16 mm  
 Accessory holder ø 16 mm



Lampes/Lamps +11910-01  
 Se référer à la  
 documentation  
 Refer to the literature

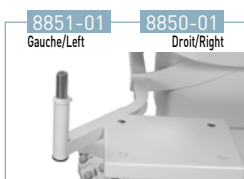

8851-01 Gauche/Left  
 8850-01 Droit/Right  
 Support colposcope Olympus  
 Olympus colposcope holder  
 (pour/for 11614-01)



11840-01  
 Support colposcope Zeiss  
 Zeiss colposcope holder











11810-01  
 Support colposcope Leisegang  
 Leisegang colposcope holder





Autres modèles  
 de supports coloscopes  
 sur demande  
 Other colposcope holders  
 available on request

Choix de selleries non-feu M1  
Antibactérien  
Choice of M1 fire retardant  
and antibacterial upholstery







Classic

-  32 - BLEU / BLUE
-  93 - COTTAGE / COTTAGE
-  35 - ROUGE / RED
-  34 - JAUNE / YELLOW
-  91 - BLANC / WHITE
-  92 - MARINE / MARINE
-  56 - OBSCURE / DARKNESS
-  57 - ANTISTATIQUE / ANTISTATIC  
Non classé M1 / Not classified M1

Vitamin

-  64 - RAISIN / GRAPE
-  67 - LAGON / LAGOON
-  66 - BONBON / SWEET
-  63 - CEDRAT / CEDRAT

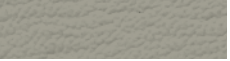
Cosy

-  80 - CIEL / SKY
-  81 - VERT D'EAU / SEA GREEN
-  65 - LILAS / LILAC
-  96 - ETAIN / TIN
-  82 - GRIS SOURIS / MOUSE GREY
-  83 - NATUREL / NATURAL
-  84 - CHOCOLAT / CHOCOLATE

ANTIBACTÉRIEN / NON FEU M1 - ANTIBACTERIAL / M1 FIRE RETARDANT

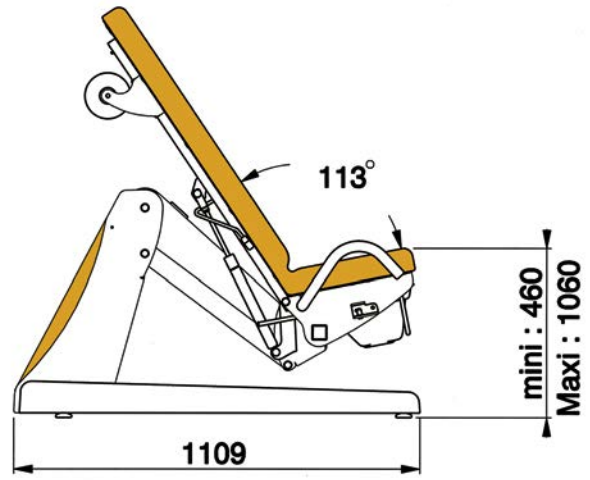
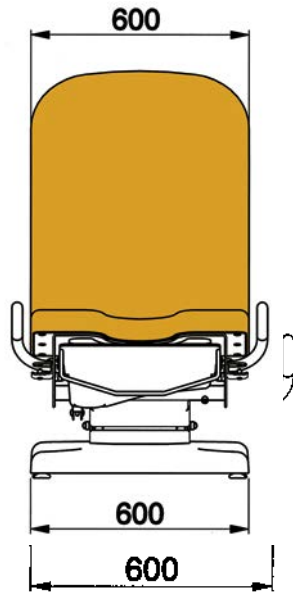

Poids net  
Net weight  
95 kg

Poids brut  
Gross weight  
135 kg

Volume  
0,92 m<sup>3</sup>

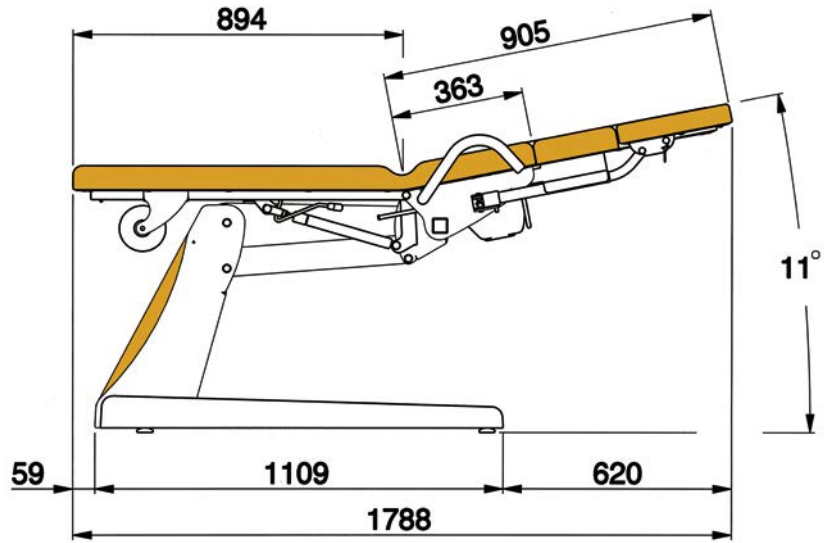

FE-05/19

